

# TEXAS-3X



5-20 cm

3D letters, lightboxes



- luminous efficacy 92 lm/W
- for indoor and outdoor use
- 20 pcs in chain

## DIMENSIONS

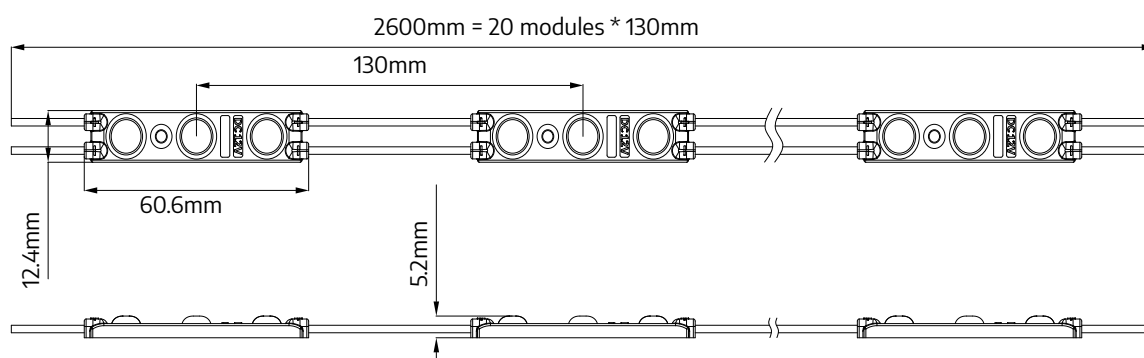

## TECHNICAL SPECIFICATION

Parameter	Value
Rated voltage	12 V DC
Power consumption per module	0,72 W
Chain power consumption	14,4 W
Current consumption per module	60 mA
LED diodes	EPISTAR - 2835
Quantity of LEDs	3
Light color	X = W - white (6500K) X = CW - cool white (9500K) X = R - red (620nm) X = G - green (520nm) X = B - blue (460nm)
Flux	66 lm (W) 71 lm (CW)
Flux density	92 lm/W (W) 99 lm/W (CW)
Color rendering index CRI	≥80 (on request ≥90, ≥95)
Beam angle	160°
Current stabilization	No
Dimming	Yes
Module dimensions (L × W × H)	61 × 12 × 5 mm
Cable length	70 mm
Number of modules in 1 m	7,7
Box weight	17 kg
Montage	Adhesive tape / mounting screw
Lifetime	L70B50 > 50000h
Working temperature	-25°C ... +55°C
IP protection	IP67
Warranty	4 years

# TEXAS-3X



## CONNECTION DIAGRAM

One-side power input



Maximum number of modules 20 pcs

Two-side power input



Maximum number of modules 40 pcs

It is acceptable to connect multiple chains in parallel, as long as the power supply provides sufficient power.

## ENERGY LABEL / BEAM ANGLE

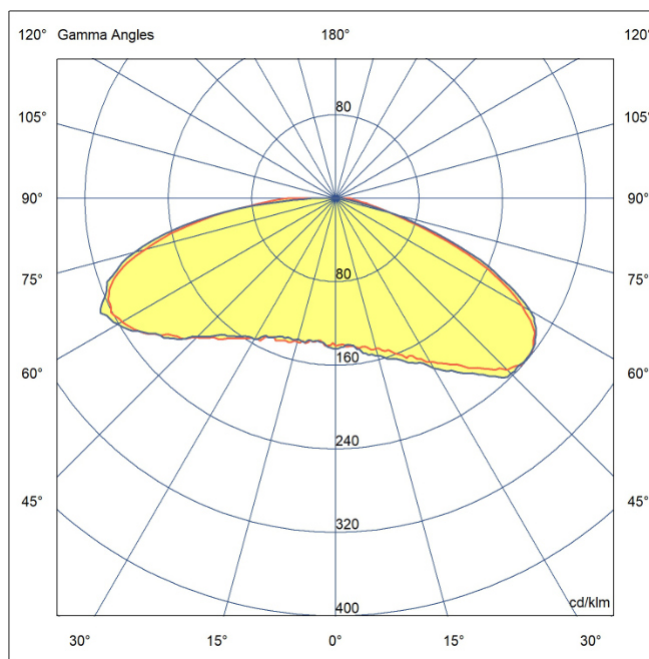
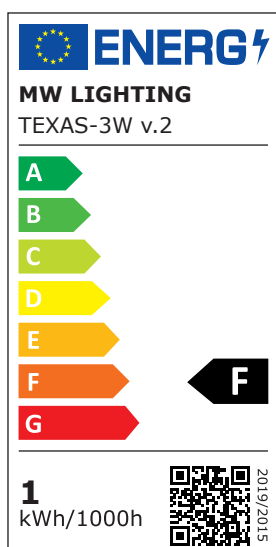

## LIGHT COLOR / CCT

Abbreviation	Light color	CCT
WW	warm white	~3000K
NW	neutral white	~4000K
W	white	~6500K
CW	cold white	~9500K

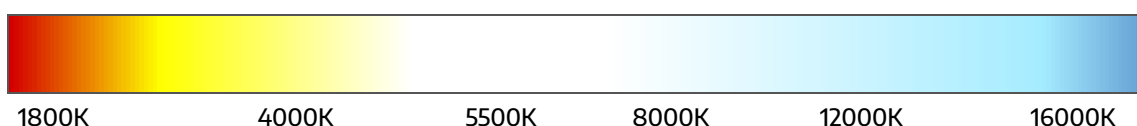

## APPLICATION

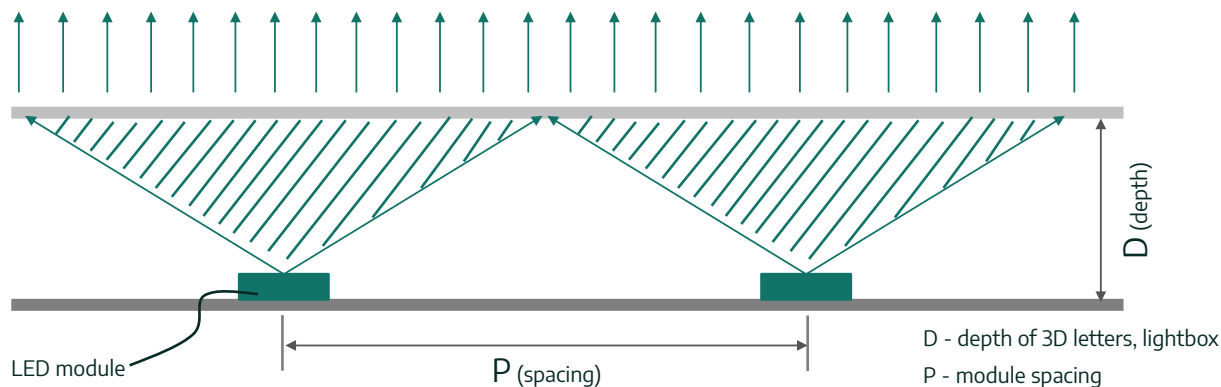

$$\text{optical performance proportion} = \frac{D}{P} = 1:1.5$$

## PACKING

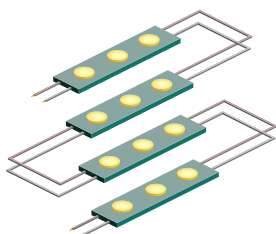

Chain  
**20 pcs**



Bag  
**100 pcs**

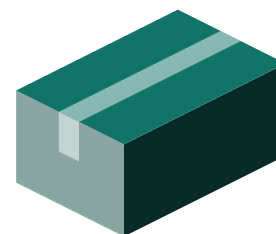

Box  
**2600 pcs**

## OTHER NOTES

The 3M tape placed on the device is only used to pre-attach and position the LED modules. Use your own glue or mounting screw to securely and permanently attach the item to the surface.